

Fieldbook

Arthur Clement

Anvil Hurricane



Mcalister Press[®]

Fieldbook

Arthur Clement



Casse Aerospace originally built the Hurricane in 2607 for the UEE Navy to use in the Second Tevarin War. The Tevarin phalanx shield tech had proven to be so effective, the Navy needed a new weapon to try and penetrate their defenses. Designed to capitalize on those critical moments when phalanx shields faltered, the Hurricane would unload all its available firepower as quickly as possible. Built intentionally light with power focused on weapons and thrusters, any extra room aboard was dedicated to ammo storage. Unfortunately, by the time the Hurricane was deployed late in the war, it only saw limited action in battle but left a lasting impression on those who flew it.



Fieldbook

Arthur Clement



Cockpit Interior

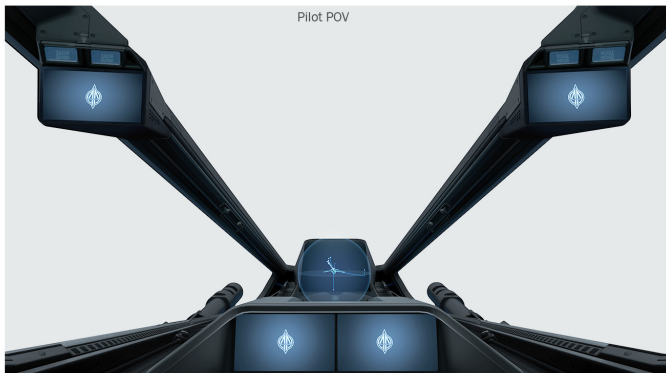

Pilot POV



Turret Interior



Besides its overpowering offensive capabilities, one of the Hurricane's most distinguishing features is the pilot entry method. The pilot seat deploys from the ship's belly, allowing expedited take off procedures when precious seconds count. Supposedly, Anvil used the Hurricane's entry method as inspiration for the Gladiator, so when Anvil won the UEE Navy contract to remake the Hurricane, they upgraded the seat's hydraulic lift to match.

Though built for the Second Tevarin War, the Hurricane saw limited action late in the conflict and the ship was subsequently decommissioned. However, following a 2871 report that showed the longer a Human pilot engaged a Vanduul ship the less likely they were to survive, the ship's "focused firepower" design, clearly seen in the top-down view, was resurrected by the Navy.

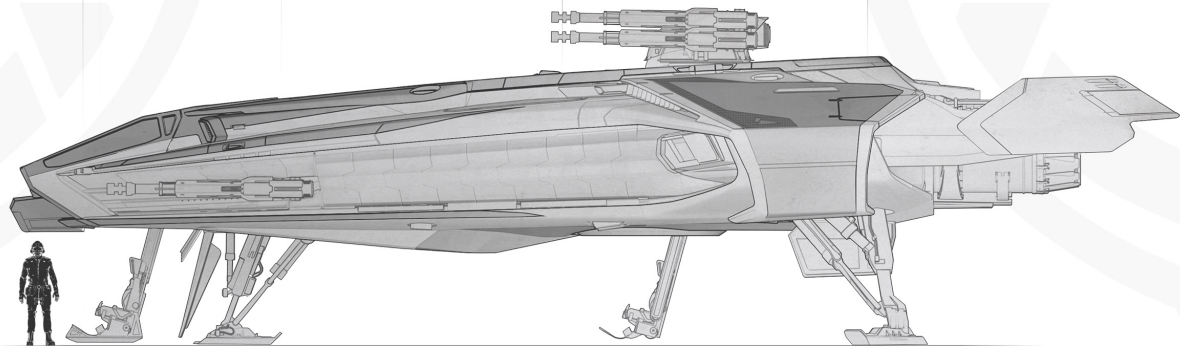
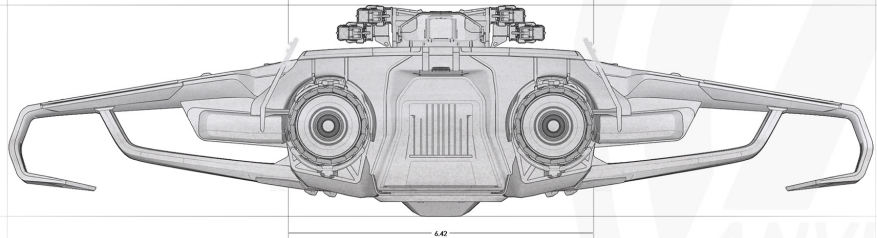
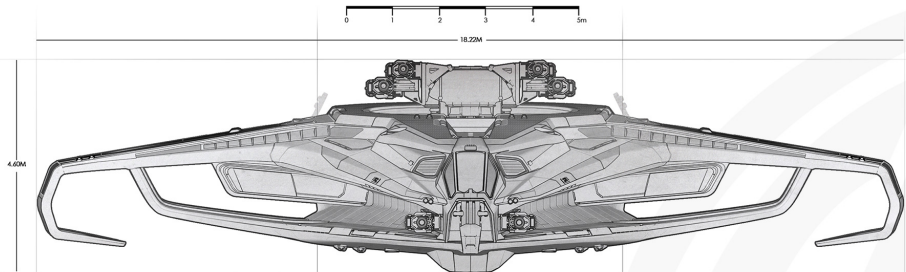
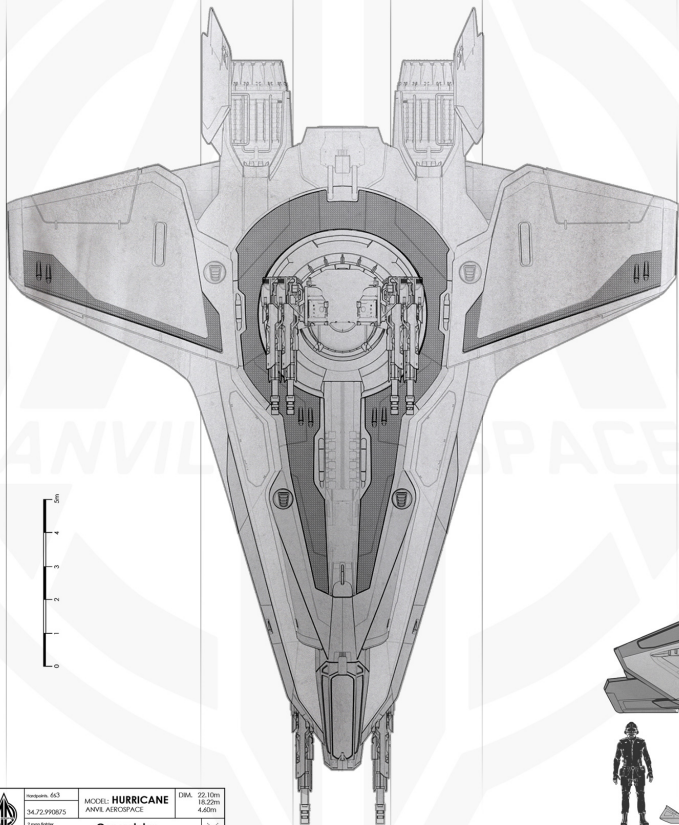

	Item No: 643	MODEL: HURRICANE	DRG: 22 1000
	SA:23:098073	ANVIL ASSOCIATES	18.25m 4.60m
	Drawn by: [signature]		
	Author: [signature]		
-Generalplan-			<input checked="" type="checkbox"/>

- 1 - Nose hardpoints - Size 4 (x2)
- 2 - Manned Turret - Size 3 Hardpoints (x4)
- 3 - Maneuvering Thruster
- 4 - Retro Thruster
- 5 - Missile Bay - Size 3 missile hardpoint (x2) - Size 2 missiles (x4)
- 6 - Main Thruster
- 7 - Fuel Tank Compartment
- 8 - Ship Item Compartment
- 9 - Manned Turret Access
- 10 - Cockpit Access
- 11 - Landing Gear Compartment

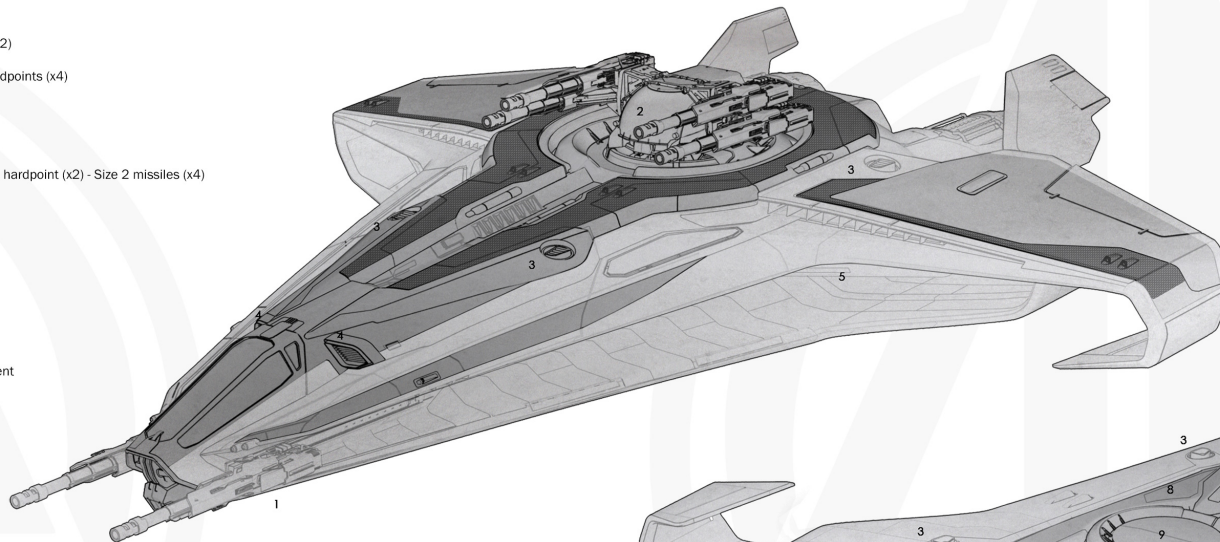

27th century UEE Navy Rear Admiral Denzel Zimmerman famously described the Hurricane as "a mobile turret." Every last centimeter of the ship, from its nose mounted guns to its unique quad-gun turret design, was crafted to make it as offensively devastating as possible. Since that configuration comes at the cost of defensive measures, the ship was given a slimmer profile to make it more difficult to hit.

- 1 - Pilot entry
- 2 - Turret entry

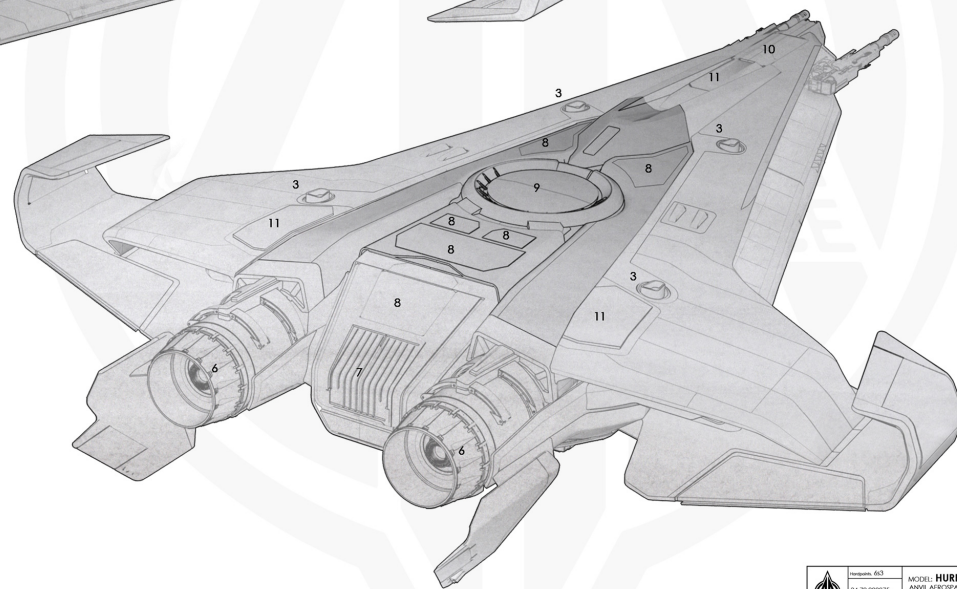
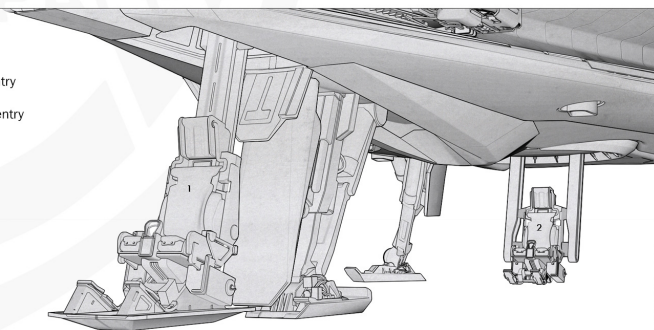



Anvil Aerospace's resurrection of the Hurricane was an immediate success for the Navy. Within its first week of deployment in the Caliban System in 2878, Hurricane pilots and gunners scored an impressive number of confirmed Vanduul kills. In 2884, witnesses to the Fall of Caliban claimed the Hurricane played an instrumental role clearing paths to jump points for the evacuation of civilians.



- Advocacy



Thanks to its enduring speed and devastating arsenal, Hurricanes have become an instrumental part of the UEE Marine Expeditionary Brigades. Where pilots rely on hard-hitting tactics to clear the way for planetary assault ground forces.

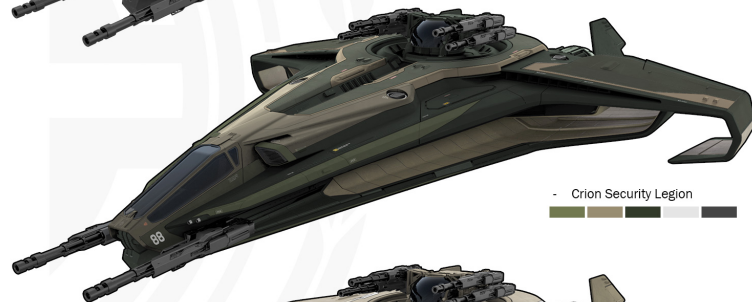

- Crion Security Legion



- Corel Customs Patrol



Argul Dawn came to prominence after a number of daring raids against supply ships destined for Lago, Nexus System. At carefully selected spots, Hurricanes would ambush a convoy and eliminate support ships before they could retaliate. Argul Dawn's ruthless effectiveness prompted the Advocacy to conduct a number of high-risk raids of their Echo 11 headquarters.



- Sang Gestas



- Xeno Threat



- Coriolus Initiative



Hurricanes played an influential part in the Otoni Syndicate's infamous 2941 heist of precious ores destined for ArcCorp. Following an EMP blast, the ship's expertly focused firepower quickly crippled the lightly shielded haulers, rendering them immobile and ready for boarding. The economic impact on ArcCorp caused a ripple effect that was felt across the Empire.



- Screaming Galsons



- Makarel Marauders





Mcalister Press' award-winning Fieldbook series is dedicated to presenting a perfect blend of educational and entertaining information about the vehicles and items that have come to define modern life, making them essential reading for enthusiasts and casual fans across the UEE.

CHECK OUT THE REST OF
OUR FIELDBOOK SHIP SERIES

TO LEARN ABOUT OTHER FAMOUS
UEE VESSELS, PROUDLY BROUGHT
TO YOU BY MCALISTER PRESS.

